

INSTRUCTION MANUAL

DEWALT®

D28114N-XE

HEAVY-DUTY SMALL ANGLE GRINDER



Definitions: Safety Guidelines

The definitions below describe the level of severity for each signal word. Please read the manual and pay attention to these symbols.

⚠DANGER: Indicates an imminently hazardous situation which, if not avoided, **will** result in **death or serious injury**.

⚠WARNING: Indicates a potentially hazardous situation which, if not avoided, **could** result in **death or serious injury**.

⚠CAUTION: Indicates a potentially hazardous situation which, if not avoided, **may** result in **minor or moderate injury**.

NOTICE: Indicates a practice **not related to personal injury** which, if not avoided, **may** result in **property damage**.

IF YOU HAVE ANY QUESTIONS OR COMMENTS ABOUT THIS OR ANY DEWALT TOOL, CALL US AT: **1800 444 224** (Aust) or **0800 339 258** (NZ).

Technical Data

D28114N-XE		
Voltage	V	230
Power input	W	1400
No-load/rated speed	min ⁻¹	11,000
Wheel diameter	mm	125
Spindle diameter		M14
Weight	kg	2.1*
* weight includes side handle and guard		
L_{PA} (sound pressure)	dB(A)	90
K_{PA} (sound pressure uncertainty)	dB(A)	5.0
L_{WA} (sound power)	dB(A)	101
K_{WA} (sound power uncertainty)	dB(A)	5.0

Vibration total values (triax vector sum) determined according to EN 60745:

Vibration emission value $a_{h,AG}$ surface grinding

$a_{h,AG} =$	m/s ²	8.0
Uncertainty K =	m/s ²	1.6

Vibration emission value $a_{h,DS}$ disc sanding

$a_{h,DS} =$	m/s ²	4.0
Uncertainty K =	m/s ²	1.5

The vibration emission level given in this information sheet has been measured in accordance with a standardised test given in EN 60745 and may be used to compare one tool with another. It may be used for a preliminary assessment of exposure.

⚠ WARNING: The declared vibration emission level represents the main applications of the tool. However if the tool is used for different applications, with different accessories or poorly maintained, the vibration emission may differ. This may significantly increase the exposure level over the total working period.

An estimation of the level of exposure to vibration should also take into account the times when the tool is switched off or when it is running but not actually doing the job. This may significantly reduce the exposure level over the total working period.

Identify additional safety measures to protect the operator from the effects of vibration such as: maintain the tool and the accessories, keep the hands warm, organisation of work patterns.

SAFETY INSTRUCTIONS FOR POWER TOOLS

When using power tools, always observe the safety regulations applicable in your country to reduce the risk of fire, electric shock and personal injury. Read the following safety instructions before attempting to operate this product. Keep these instructions in a safe place.



WARNING: To reduce the risk of injury, user must read the instruction manual.

GENERAL POWER TOOL SAFETY WARNINGS



WARNING! Read all safety warnings and all instructions. Failure to follow the warnings and instructions may result in electric shock, fire and/or serious injury.

SAVE ALL WARNINGS AND INSTRUCTIONS FOR FUTURE REFERENCE

The term "power tool" in the warnings refers to your mains-operated (corded) power tool or battery-operated (cordless) power tool.

1) WORK AREA SAFETY

- a) **Keep work area clean and well lit.** Cluttered or dark areas invite accidents.
- b) **Do not operate power tools in explosive atmospheres, such as in the presence of flammable liquids, gases or dust.** Power tools create sparks which may ignite the dust or fumes.
- c) **Keep children and bystanders away while operating a power tool.** Distractions can cause you to lose control.

2) ELECTRICAL SAFETY

- a) **Power tool plugs must match the outlet. Never modify the plug in any way. Do not use any adapter plugs with earthed (grounded) power tools.** Unmodified plugs and matching outlets will reduce risk of electric shock.
- b) **Avoid body contact with earthed or grounded surfaces such as pipes, radiators, ranges and refrigerators.** There is an increased risk of electric shock if your body is earthed or grounded.
- c) **Do not expose power tools to rain or wet conditions.** Water entering a power tool will increase the risk of electric shock.
- d) **Do not abuse the cord. Never use the cord for carrying, pulling or unplugging the power tool. Keep cord away from heat, oil, sharp edges or moving parts.** Damaged or entangled cords increase the risk of electric shock.
- e) **When operating a power tool outdoors, use an extension cord suitable for outdoor use.** Use of a cord suitable for outdoor use reduces the risk of electric shock.
- f) **If operating a power tool in a damp location is unavoidable, use a residual current device (RCD) protected supply.** Use of an RCD reduces the risk of electric shock.

3) PERSONAL SAFETY

- a) **Stay alert, watch what you are doing and use common sense when operating a power tool. Do not use a power tool while you are tired or under the influence of drugs, alcohol or medication.** A moment of inattention while operating power tools may result in serious personal injury.
- b) **Use personal protective equipment. Always wear eye protection.** Protective equipment such as dust mask, non-skid safety shoes, hard hat, or hearing protection used for appropriate conditions will reduce personal injuries.
- c) **Prevent unintentional starting. Ensure the switch is in the off position before connecting to power source and/or battery pack, picking up or carrying the tool.** Carrying power tools with your finger on the switch or energising power tools that have the switch on invites accidents.
- d) **Remove any adjusting key or wrench before turning the power tool on.** A wrench or a key left attached to a rotating part of the power tool may result in personal injury.
- e) **Do not overreach. Keep proper footing and balance at all times.** This enables better control of the power tool in unexpected situations.
- f) **Dress properly. Do not wear loose clothing or jewellery. Keep your hair, clothing and gloves away from moving parts.** Loose clothes, jewellery or long hair can be caught in moving parts.
- g) **If devices are provided for the connection of dust extraction and collection facilities, ensure these are connected and properly used.** Use of dust collection can reduce dust-related hazards.

4) POWER TOOL USE AND CARE

- a) **Do not force the power tool. Use the correct power tool for your application.** The correct power tool will do the job better and safer at the rate for which it was designed.
- b) **Do not use the power tool if the switch does not turn it on and off.** Any power tool that cannot be controlled with the switch is dangerous and must be repaired.
- c) **Disconnect the plug from the power source and/or the battery pack from the power tool before making any adjustments, changing accessories, or storing power tools.** Such preventive safety measures reduce the risk of starting the power tool accidentally.

- d) **Store idle power tools out of the reach of children and do not allow persons unfamiliar with the power tool or these instructions to operate the power tool.** Power tools are dangerous in the hands of untrained users.
- e) **Maintain power tools. Check for misalignment or binding of moving parts, breakage of parts and any other condition that may affect the power tool's operation. If damaged, have the power tool repaired before use.** Many accidents are caused by poorly maintained power tools.
- f) **Keep cutting tools sharp and clean.** Properly maintained cutting tools with sharp cutting edges are less likely to bind and are easier to control.
- g) **Use the power tool, accessories and tool bits, etc. in accordance with these instructions, taking into account the working conditions and the work to be performed.** Use of the power tool for operations different from those intended could result in a hazardous situation.

5) SERVICE

- a) **Have your power tool serviced by a qualified repair person using only identical replacement parts.** This will ensure that the safety of the power tool is maintained.

6) STANDARD WHEEL DIMENSIONS

Wheel Type	Wheel dimensions (diameter x thickness x bore diameter) mm	Average Burst Speed min ⁻¹	Pre-Cut Length Range mm
Type 27	115 x 6 x 22.23	10200	37.6 to 39.6
	125 x 6 x 22.23	9800	42.7 to 45.7
	180 x 6 x 22.23	5900	67.3 to 72.1
	230 x 6 x 22.23	5700	83.3 to 93.5

- a) **Do not use Type 11 (flaring cup) wheels on this tool.** Using inappropriate accessories can result in injury.
- b) **Always use side handle. Tighten the handle securely.** The side handle should always be used to maintain control of the tool at all times.

Electrical Safety

The electric motor has been designed for one voltage range only. Always check that the power supply corresponds to the voltage on the rating plate. 220–240 V AC

means your tool will operate on alternating current. Operation at a voltage outside this range can cause loss of power and can result in overheating. All DeWALT tools are factory tested; if this tool does not operate, check the power supply. Your DeWALT tool is double insulated, therefore no earth wire is required.

- **Young children and the infirm.** This appliance is not intended for use by young children or infirm persons without supervision.
 - This appliance is not intended for use by persons (including children) with reduced physical, sensory or mental capabilities, or lack of experience and knowledge, unless they have been given supervision or instruction concerning use of the appliance by a person responsible for their safety.
 - Children should be supervised to ensure that they do not play with the appliance.
- **Replacement of the supply cord.** If the supply cord or plug is damaged, it must be replaced by the manufacturer or an authorised DeWALT Service Centre in order to avoid a hazard.

Extension Cords

⚠ CAUTION: Use only extension cords that are approved by the country's Electrical Authority. Before using extension cords, inspect them for loose or exposed wires, damaged insulation and defective fittings. Replace the cord if necessary.

Safety Warnings Common for Grinding, Sanding, Wire Brushing, Polishing or Abrasive Cutting-Off Operations:

- a) **This power tool is intended to function as a grinder, sander, wire brush, polisher or cut-off tool.** Read all safety warnings, instructions, illustrations and specifications provided with this power tool. Failure to follow all instructions listed below may result in electric shock, fire and/or serious injury.
- b) **Do not use accessories which are not specifically designed and recommended by the tool manufacturer.** Just because the accessory can be attached to your power tool, it does not assure safe operation.
- c) **The rated speed of the accessory must be at least equal to the maximum speed marked on the power tool.** Accessories running faster than their rated speed can break and fly apart.
- d) **The outside diameter and the thickness of your accessory must be within the capacity rating of your power tool.** Incorrectly sized accessories cannot be adequately guarded or controlled.

- e) **The arbour size of wheels, flanges, backing pads or any other accessory must properly fit the spindle of the power tool.** Accessories with arbour holes that do not match the mounting hardware of the power tool will run out of balance, vibrate excessively and may cause loss of control.
- f) **Do not use a damaged accessory. Before each use, inspect the accessory such as abrasive wheels for chips and cracks, backing pad for cracks, tear or excess wear, wire brush for loose or cracked wires. If power tool or accessory is dropped, inspect for damage or install an undamaged accessory. After inspecting and installing an accessory, position yourself and bystanders away from the plane of the rotating accessory and run the power tool at maximum no-load speed for one minute.** Damaged accessories will normally break apart during this test time.
- g) **Wear personal protective equipment. Depending on application, use face shield, safety goggles or safety glasses. As appropriate, wear dust mask, hearing protectors, gloves and workshop apron capable of stopping small abrasive or workpiece fragments.** The eye protection must be capable of stopping flying debris generated by various operations. The dust mask or respirator must be capable of filtrating particles generated by your operation. Prolonged exposure to high intensity noise may cause hearing loss.
- h) **Keep bystanders a safe distance away from work area. Anyone entering the work area must wear personal protective equipment.** Fragments of workpiece or of a broken accessory may fly away and cause injury beyond immediate area of operation.
- i) **Hold power tool by insulated gripping surfaces only, when performing an operation where the cutting accessory may contact hidden wiring or its own cord.** Cutting accessory contacting a "live" wire may make exposed metal parts of the power tool "live" and shock the operator.
- j) **Position the cord clear of the spinning accessory.** If you lose control, the cord may be cut or snagged and your hand or arm may be pulled into the spinning accessory.
- k) **Never lay the power tool down until the accessory has come to a complete stop.** The spinning accessory may grab the surface and pull the power tool out of your control.
- l) **Do not run the power tool while carrying it at your side.** Accidental contact with the spinning accessory could snag your clothing, pulling the accessory into your body.
- m) **Regularly clean the power tool's air vents.** The motor's fan will draw the dust inside the housing and excessive accumulation of powdered metal may cause electrical hazards.
- n) **Do not operate the power tool near flammable materials.** Sparks could ignite these materials.
- o) **Do not use accessories that require liquid coolants.** Using water or other liquid coolants may result in electrocution or shock.

Further Safety Instructions for All Operations

KICKBACK AND RELATED WARNINGS

Kickback is a sudden reaction to a pinched or snagged rotating wheel, backing pad, brush or any other accessory. Pinching or snagging causes rapid stalling of the rotating accessory which in turn causes the uncontrolled power tool to be forced in the direction opposite of the accessory's rotation at the point of the binding.

For example, if an abrasive wheel is snagged or pinched by the workpiece, the edge of the wheel that is entering into the pinch point can dig into the surface of the material causing the wheel to climb out or kick out. The wheel may either jump toward or away from the operator, depending on direction of the wheel's movement at the point of pinching. Abrasive wheels may also break under these conditions.

Kickback is the result of tool misuse and/or incorrect operating procedures or conditions and can be avoided by taking proper precautions as given below:

- a) **Maintain a firm grip on the power tool and position your body and arm to allow you to resist kickback forces. Always use auxiliary handle, if provided, for maximum control over kickback or torque reaction during start up.** The operator can control torque reaction or kickback forces, if proper precautions are taken.
- b) **Never place your hand near the rotating accessory.** Accessory may kickback over your hand.
- c) **Do not position your body in the area where power tool will move if kickback occurs.** Kickback will propel the tool in direction opposite to the wheel's movement at the point of snagging.
- d) **Use special care when working corners, sharp edges etc.** Avoid bouncing and snagging the accessory. Corners, sharp edges or bouncing have a tendency to snag the rotating accessory and cause loss of control or kickback.

- e) **Do not attach a saw chain woodcarving blade or toothed saw blade.** Such blades create frequent kickback and loss of control.

Safety Warnings Specific for Grinding and Abrasive Cutting-Off Operations

- a) **Use only wheel types that are recommended for your power tool and the specific guard designed for the selected wheel.** Wheels for which the power tool was not designed cannot be adequately guarded and are unsafe.
- b) **The guard must be securely attached to the power tool and positioned for maximum safety, so the least amount of wheel is exposed towards the operator.** The guard helps to protect operator from broken wheel fragments and accidental contact with wheel and sparks that could ignite clothing.
- c) **Wheels must be used only for recommended applications. For example: do not grind with the side of cut-off wheel.** Abrasive cut-off wheels are intended for peripheral grinding, side forces applied to these wheels may cause them to shatter.
- d) **Always use undamaged wheel flanges that are of correct size and shape for your selected wheel.** Proper wheel flanges support the wheel thus reducing the possibility of wheel breakage. Flanges for cut-off wheels may be different from grinding wheel flanges.
- e) **Do not use worn down wheels from larger power tools.** Wheel intended for larger power tool is not suitable for the higher speed of a smaller tool and may burst.

Additional Safety Warnings Specific for Abrasive Cutting-Off Operations

- a) **Do not “jam” the cut-off wheel or apply excessive pressure. Do not attempt to make an excessive depth of cut.** Overstressing the wheel increases the loading and susceptibility to twisting or binding of the wheel in the cut and the possibility of kickback or wheel breakage.
- b) **Do not position your body in line with and behind the rotating wheel.** When the wheel, at the point of operations, is moving away from your body, the possible kickback may propel the spinning wheel and the power tool directly at you.
- c) **When wheel is binding or when interrupting a cut for any reason, switch off the power tool and hold the power tool motionless until the wheel comes to a complete stop. Never attempt to remove the cut-off wheel from the cut while**

the wheel is in motion otherwise kickback may occur. Investigate and take corrective action to eliminate the cause of wheel binding.

- d) **Do not restart the cutting operation in the workpiece. Let the wheel reach full speed and carefully re-enter the cut.** The wheel may bind, walk up or kickback if the power tool is restarted in the workpiece.
- e) **Support panels or any oversized workpiece to minimize the risk of wheel pinching and kickback.** Large workpieces tend to sag under their own weight. Supports must be placed under the workpiece near the line of cut and near the edge of the workpiece on both sides of the wheel.
- f) **Use extra caution when making a “pocket cut” into existing walls or other blind areas.** The protruding wheel may cut gas or water pipes, electrical wiring or objects that can cause kickback.

Safety Warnings Specific for Sanding Operations

- a) **Do not use excessively oversized sanding disc paper. Follow manufacturer's recommendations, when selecting sanding paper.** Larger sanding paper extending beyond the sanding pad presents a laceration hazard and may cause snagging, tearing of the disc or kickback.

Safety Warnings Specific for Polishing Operations

- a) **Do not allow any loose portion of the polishing bonnet or its attachment strings to spin freely. Tuck away or trim any loose attachment strings.** Loose and spinning attachment strings can entangle your fingers or snag on the workpiece.

Safety Warnings Specific for Wire Brushing Operations

- a) **Be aware that wire bristles are thrown by the brush even during ordinary operation. Do not overstress the wires by applying excessive load to the brush.** The wire bristles can easily penetrate light clothing and/or skin.
- b) **If the use of a guard is recommended for wire brushing, do not allow any interference of the wire wheel or brush with the guard.** Wire wheel or brush may expand in diameter due to work and centrifugal forces.

Additional Specific Safety Warnings for Grinders

- Check that the grinding wheel backing flange has a yellow rubber ring (C) installed, see Figure 1. Replace rubber ring if missing, damaged or worn. See pages 9–10 for details regarding proper accessory installation.

⚠ WARNING: The grinding wheel or accessory may loosen during coast-down of the tool when shut off if rubber ring is missing or damaged. If grinding wheel or accessory loosens, it may dismount from the machine and may cause serious personal injury.

- **Do not use circular saw blades or any other toothed blades with this tool.** Serious injury may result.
- **Avoid bouncing the wheel or giving it rough treatment.** If this occurs, stop the tool and inspect the wheel for cracks or flaws.
- **Do not operate this tool for long periods of time.** Vibration caused by the operating action of this tool may cause permanent injury to fingers, hands, and arms. Use gloves to provide extra cushion, take frequent rest periods, and limit daily time of use.
- **Direct the Dust Ejection System (DES) away from operator and coworkers.** Serious injury may result (Fig. 1, I).

⚠ WARNING: We recommend the use of a residual current device with a residual current rating of 30mA or less.

⚠ WARNING: ALWAYS wear approved protective safety equipment complying with the following standards:

- Eye protection: AS/NZS1337 Eye Protectors for Industrial Applications;
- Hearing protection: AS/NZS1270 Acoustics – Hearing Protection;
- Respiratory protection: AS/NZS1716 Respiratory Protective Devices.

⚠ WARNING: Some dust created by power sanding, sawing, grinding, drilling, and other construction activities contains chemicals known to cause cancer, birth defects or other reproductive harm. Some examples of these chemicals are:

- lead from lead-based paints,
- crystalline silica from bricks and cement and other masonry products, and
- arsenic and chromium from chemically-treated lumber.

Your risk from these exposures varies, depending on how often you do this type of work. To reduce your exposure to these chemicals: work in a well ventilated area, and work with approved safety equipment, such as those dust masks that are specially designed to filter out microscopic particles.

- **Avoid prolonged contact with dust from power sanding, sawing, grinding, drilling, and other construction activities. Wear protective clothing and wash**

exposed areas with soap and water. Allowing dust to get into your mouth, eyes, or lay on the skin may promote absorption of harmful chemicals.

⚠ WARNING: Use of this tool can generate and/or disburse dust, which may cause serious and permanent respiratory or other injury. Always use AS/NZS1716 approved respiratory protection appropriate for the dust exposure. Direct particles away from face and body.

⚠ WARNING: Always wear proper personal hearing protection that conforms to AS/NZS1270 during use. Under some conditions and duration of use, noise from this product may contribute to hearing loss.

- The label on your tool may include the following symbols. The symbols and their definitions are as follows:

V	volts	A	amperes
Hz	hertz	W	watts
min	minutes	~	alternating current
— — — —	direct current	⌚	alternating or direct current
⊕	Class I Construction (grounded)	n ₀	no load speed
□	Class II Construction (double insulated)	n	rated speed
.../min	per minute	⊕	earthing terminal
IPM	impacts per minute	⚠	safety alert symbol
SPM	strokes per minute	BPM	beats per minute
		RPM	revolutions per minute
		sfpn	surface feet per minute

SAVE ALL WARNINGS AND INSTRUCTIONS FOR FUTURE REFERENCE

Package Contents

- 1 D28114 angle grinder
- 1 Side handle
- 1 Spanner
- 1 DW4619 Type 27 125 mm metal grinding disc
- 1 Instruction manual
- 1 Warranty sheet

- Check for damage to the tool, parts or accessories which may have occurred during transport.
- Take the time to thoroughly read and understand this manual prior to operation.

COMPONENTS (Fig. 1)

⚠ WARNING: Never modify the power tool or any part of it. Damage or personal injury could result.

- | | |
|---|--------------------------------|
| A. Paddle switch | F. Quick-change backing flange |
| B. Spindle lock button | G. Threaded clamp nut |
| C. Yellow rubber ring | H. Type 27 guard |
| D. Anti-vibration side handle (D, Fig. 2) | I. Dust Ejection System™ (DES) |
| E. 5" Grinding wheel (Type 27) | |

FIG. 1

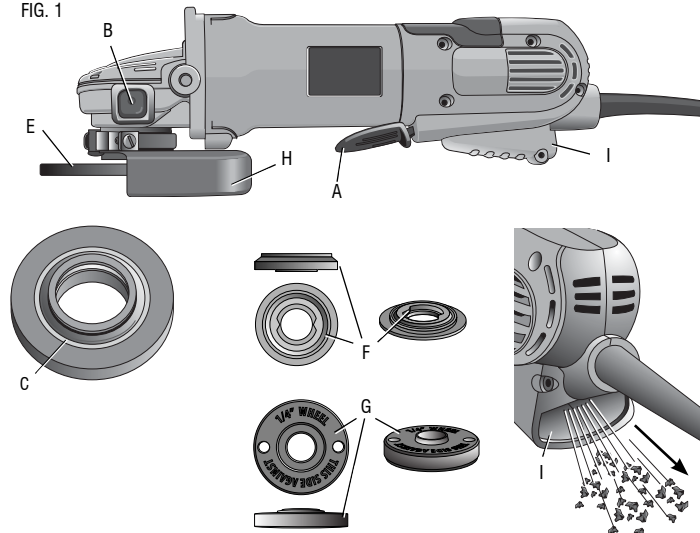

INTENDED USE

The D28114N-XE heavy-duty small angle grinder has been designed for professional grinding, polishing and cutting applications.

DO NOT use grinding wheels other than center depressed wheels and flap-disk.

DO NOT use under wet conditions or in presence of flammable liquids or gases.

This small angle grinder is a professional power tool.

DO NOT let children come into contact with the tool. Supervision is required when inexperienced operators use this tool.

E-Switch Protection™

The paddle switch has a no-volt release function. In the event of a power outage or other unexpected shut down, the switch needs to be cycled (turned off and on) to restart tool.

E-Clutch™

This unit is equipped with an E-Clutch™ (Electronic Clutch), which in the event of a high-load or wheel pinch, the unit will shut off to reduce the reaction torque to the user. The paddle switch needs to be cycled (turned off and on) to restart the tool.

Power-off™ Overload Protection

The power supply to the motor will be reduced in case of motor overload. With continued motor overload, the tool will shut off. The paddle switch must be cycled (turned off and on) to restart tool. The power will return to normal once the tool has cooled down to a suitable operating temperature. Note: Run the tool at no load to reduce the cool down time.

Complete Electronic Control™

The internal electronic speed control offers consistent wheel speed while using the tool.

ASSEMBLY AND ADJUSTMENTS

⚠ WARNING: To reduce the risk of serious personal injury, turn off and unplug the tool before making any adjustments or removing or installing attachments or accessories. Before reconnecting the tool, depress and release the paddle switch to ensure that the tool is off. An accidental start-up can cause injury.

Attaching Side Handle

The side handle (D) can be fitted to either side of the gear case in the threaded holes, as shown. Before using the tool, check that the handle is tightened securely. Use a wrench to firmly tighten the side handle.

Rotating the Gear Case

1. Remove guard and flanges from tool.
2. Remove the four corner screws attaching the gear case to motor housing.
3. Separating the gear case from motor housing not more than 6.35 mm (1/4"), rotate the gear case head to desired position.

NOTE: If the gear case and motor housing become separated by more than 6.35 mm (1/4"), the tool must be serviced and re-assembled by a DeWALT service center. Failure to have the tool serviced may cause brush, motor and bearing failure.

4. Re-install screws to attach the gear case to the motor housing. Tighten screws to 2 Nm. Overtightening could cause screws to strip.
5. Re-install guard and correct flanges for the appropriate accessories.

Accessories

It is important to choose the correct guards, backing pads and flanges to use with grinder accessories. Refer to pages 9–10 for information on choosing the correct accessories.

WARNING: Accessories must be rated for at least the speed recommended on the tool warning label. Wheels and other accessories running over rated accessory speed may burst and cause injury. Threaded accessories must have an M14 hub. Every unthreaded accessory must have a 22.23 mm (7/8") arbor hole. If it does not, it may have been designed for a circular saw and should not be used. Use only the accessories shown on pages 9–10 of this manual. Accessory ratings must be above listed minimum wheel speed as shown on tool nameplate.

Mounting and Removing Guard

WARNING: To reduce the risk of serious personal injury, turn off and unplug the tool before making any adjustments or removing or installing attachments or

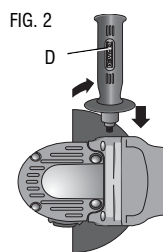

accessories. Before reconnecting the tool, depress and release the paddle switch to ensure that the tool is off. An accidental start-up can cause injury.

CAUTION: Guards must be used with all grinding wheels, sanding flap discs, wire brushes, and wire wheels. The tool may be used without a guard only when sanding with conventional sanding discs. Some DeWALT models are provided with a guard intended for use with depressed center wheels (Type 27) and hubbed grinding wheels (Type 27). The same guard is designed for use with sanding flap discs (Type 27) and wire brushes. Grinding and cutting with wheels other than Type 27 and 29 require different accessory guards not included with tool. Mounting instructions for these accessory guards are included in the accessory package.

NOTE: Please refer to pages 9–10 for information in choosing the correct accessory.

1. Open the guard latch (J). Align the lugs (K) on the guard with the slots (L) on the gear case.
2. Push the guard down until the guard lugs engage and rotate freely in the groove on the gear case hub.
3. With the guard latch open, rotate the guard (H) into the desired working position. The guard body should be positioned between the spindle and the operator to provide maximum operator protection.

FIG. 3

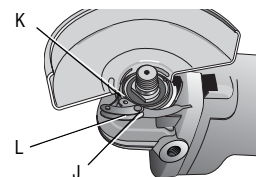
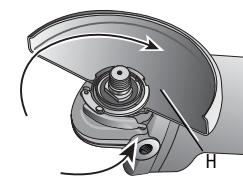
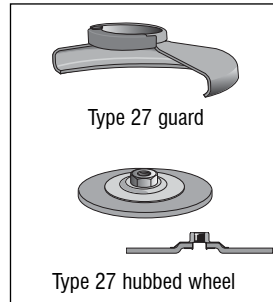
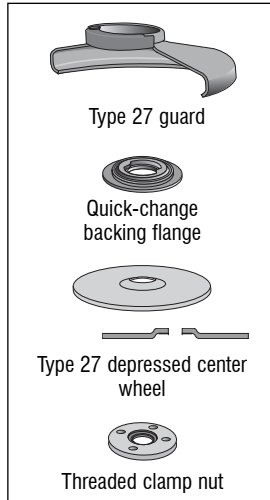

FIG. 4



4. Close the guard latch to secure the guard on the gear case. You should not be able to rotate the guard by hand when the latch is closed. Do not operate the grinder with a loose guard or the clamp lever in open position.
5. To remove the guard, open the guard latch, rotate the guard so that the arrows are aligned and pull up on the guard.

115 mm and 125 mm (4-1/2" and 5") Grinding Wheels



115 mm and 125 mm (4-1/2" and 5") Cutting Wheels

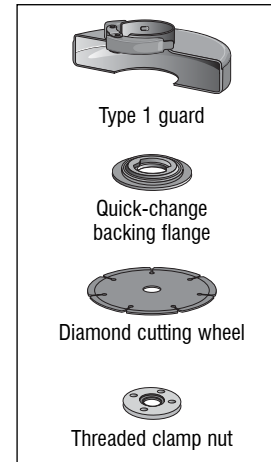
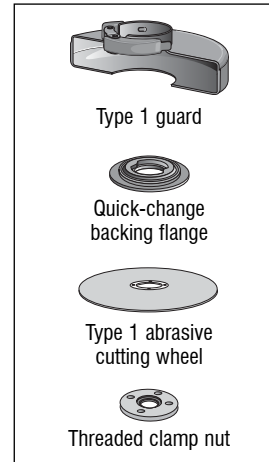

Wire Wheels

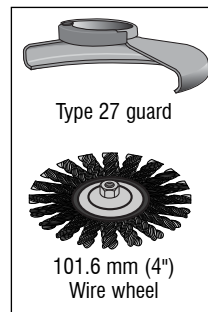
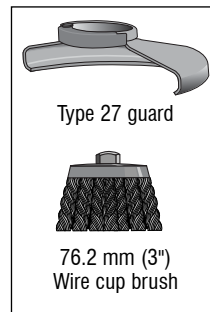

Sanding Discs

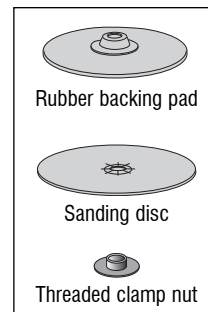

115 mm and 125 mm (4-1/2" and 5") Sanding Flap Discs

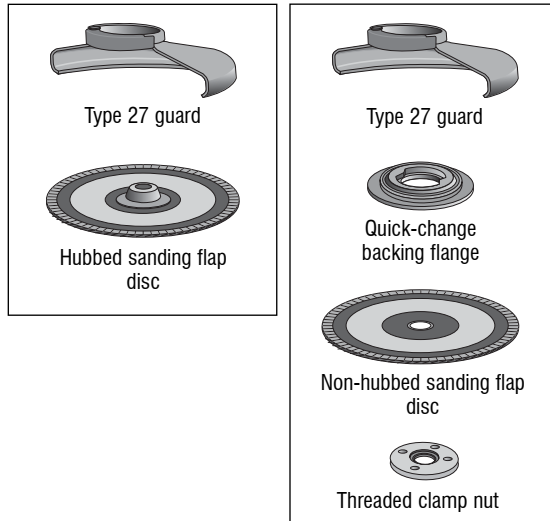

NOTE: The guard is pre-adjusted to the diameter of the gear case hub at the factory. If, after a period of time, the guard becomes loose, tighten the adjusting screw (M) with clamp lever in the closed position.

CAUTION: Do not tighten the adjusting screw with the clamp lever in open position. Undetectable damage to the guard or the mounting hub may result.

CAUTION: If guard cannot be tightened by adjusting clamp, do not use tool and take the tool and guard to a service center to repair or replace the guard.

FIG. 5

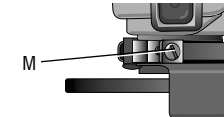

OPERATION

WARNING: To reduce the risk of serious personal injury, turn off and unplug the tool before making any adjustments or removing or installing attachments or accessories. Before reconnecting the tool, depress and release the paddle switch to ensure that the tool is off. An accidental start-up can cause injury.

Proper Hand Position

WARNING: To reduce the risk of serious personal injury, ALWAYS use proper hand position.

WARNING: To reduce the risk of serious personal injury, ALWAYS hold securely in anticipation of a sudden reaction.

Proper hand position requires one hand on side handle with the other hand on the main handle.

Guards and Flanges

It is important to choose the correct guards and flanges to use with the grinder accessories. See pages 9–10 for the correct accessories.

NOTE: Edge grinding and cutting can be performed with Type 27 wheels designed and specified for this purpose.

WARNING: Accessories must be rated for at least the speed recommended on the tool warning label. Wheels and other accessories running over rated accessory speed may burst and cause injury. Every unthreaded accessory must have a 2.23 mm (7/8") arbor hole. If it does not, it may have been designed for a circular saw and should not be used. Use only the accessories shown on pages 9–10. Accessory ratings must be above listed minimum wheel speed as shown on tool nameplate.

Switches

⚠ CAUTION: Hold the side handle and body of the tool firmly to maintain control of the tool at start up and during use and until the wheel or accessory stops rotating. Make sure the wheel has come to a complete stop before laying the tool down.

NOTE: To reduce unexpected tool movement, do not switch the tool on or off while under load conditions. Allow the grinder to run up to full speed before touching the work surface. Lift the tool from the surface before turning the tool off. Allow the tool to stop rotating before putting it down.

SOFT START FEATURE

The soft start feature allows a slow speed build-up to avoid an initial jerk when starting. This feature is particularly useful when working in confined areas. Current surge will also be reduced.

PADDLE SWITCH

⚠ CAUTION: Before connecting the tool to a power source depress and release the paddle switch (A) to ensure that the switch is off. Depress and release the paddle switch as described above after any interruption in power supply to the tool, such as the activation of a ground fault interrupter, throwing of a circuit breaker, accidental unplugging, or power failure.

To turn the tool on, depress the paddle switch (A). The tool will run while the switch is depressed. Turn the tool off by releasing the paddle switch.

⚠ WARNING: Do not disable the lock-off lever. If the lock-off lever is disabled, the tool may start unexpectedly when it is laid down.

⚠ CAUTION: Allow the tool to reach full speed before touching tool to the work surface. Lift the tool from the work surface before turning the tool off.

SPINDLE LOCK BUTTON

The spindle lock button (B) is provided to prevent the spindle (P) from rotating when installing or removing wheels. Operate the spindle lock only when the tool is turned off, unplugged from the power supply, and has come to a complete stop. Do not engage the spindle

FIG. 6



FIG. 7

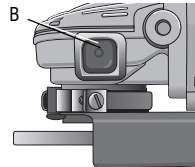

lock while the tool is operating because damage to the tool will result. To engage the lock, depress the spindle lock button (B) and rotate the spindle (P) until you are unable to rotate the spindle further.

Mounting and Using Depressed Center Grinding Wheels and Sanding Flap Discs

⚠ WARNING: To reduce the risk of serious personal injury, turn off and unplug the tool before making any adjustments or removing or installing attachments or accessories. Before reconnecting the tool, depress and release the paddle switch to ensure that the tool is off. An accidental start-up can cause injury.

MOUNTING AND REMOVING HUBBED WHEELS

Hubbed wheels install directly on the M14 threaded spindle (P). Thread of accessory must match thread of spindle.

1. The quick-change backing flange (F) is retained to the grinder by an O-ring on the spindle (P). Remove the quick-change backing flange by pulling and twisting flange away from the machine.
2. Thread the wheel on the spindle by hand.
3. Depress the spindle lock button (B) and use a wrench to tighten the hub of the wheel.
4. Reverse the above procedure to remove the wheel.

⚠ CAUTION: Failure to properly seat the wheel before turning the tool on may result in damage to the tool or the wheel.

MOUNTING NON-HUBBED WHEELS

1. Install the quick-change backing flange (F) for all non-hubbed wheels on spindle (P) with the raised section (pilot) against the wheel. Be sure the backing flange recess is seated onto the flats of the spindle by pushing and twisting the flange before placing wheel.
2. Place wheel against the backing flange, centering the wheel on the raised section (pilot) of the backing flange.

FIG. 8

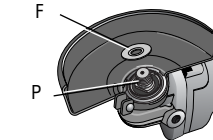
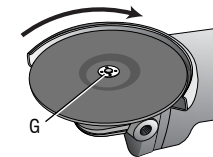

FIG. 9



- While depressing the spindle lock button, thread the clamp nut (G) on spindle. If the wheel you are installing is more than 3.17 mm (1/8") thick, place the threaded clamp nut on the spindle so that the raised section (pilot) fits into the center of the wheel. If the wheel you are installing is 3.17 mm (1/8") thick or less, place the threaded clamp nut on the spindle so that the raised section (pilot) is not against the wheel.
- While depressing the spindle lock button, tighten the clamp nut with a wrench.
- To remove the wheel, depress the spindle lock button and loosen the threaded clamp nut with a wrench.

NOTE: If the wheel spins after the clamp nut is tightened, check the orientation of the threaded clamp nut. If a thin wheel is installed with the pilot on the clamp nut against the wheel, it will spin because the height of the pilot prevents the clamp nut from holding the wheel.

SURFACE GRINDING WITH GRINDING WHEELS

- Allow the tool to reach full speed before touching the tool to the work surface.
- Apply minimum pressure to the work surface allowing the tool to operate at high speed. Grinding rate is greatest when the tool operates at high speed.
- Maintain a 20° to 30° angle between the tool and work surface.
- Continuously move the tool in a forward and back motion to avoid creating gouges in the work surface.
- Remove the tool from work surface before turning tool off. Allow the tool to stop rotating before laying it down.

FIG. 10

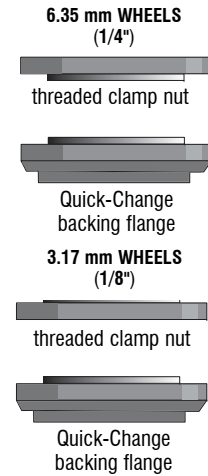

FIG. 11



EDGE GRINDING WITH GRINDING WHEELS

CAUTION: Wheels used for cutting and edge grinding may break if they bend or twist while the tool is being used to do cut-off work or deep grinding. To reduce the risk of serious injury, limit the use of these wheels with a standard Type 27 guard to shallow cutting and notching (less than 12.7 mm [1/2"] in depth). The open side of the guard must be positioned away from the operator. See the chart on pages 9–10 for more information.

- Allow the tool to reach full speed before touching the tool to the work surface.
- Apply minimum pressure to the work surface, allowing the tool to operate at high speed. Grinding rate is greatest when the tool operates at high speed.
- Position yourself so that the open-underside of the wheel is facing away from you.
- Once a cut is begun and a notch is established in the workpiece, do not change the angle of the cut. Changing the angle will cause the wheel to bend and may cause wheel breakage. Edge grinding wheels are not designed to withstand side pressures caused by bending.
- Remove the tool from the work surface before turning the tool off. Allow the tool to stop rotating before laying it down.

WARNING: Do not use edge grinding/cutting wheels for surface grinding applications because these wheels are not designed for side pressures encountered with surface grinding. Wheel breakage and injury may result.

SURFACE FINISHING WITH SANDING FLAP DISCS

- Allow the tool to reach full speed before touching the tool to the work surface.
- Apply minimum pressure to work surface, allowing the tool to operate at high speed. Sanding rate is greatest when the tool operates at high speed.
- Maintain a 5° to 10° angle between the tool and work surface.
- Continuously move the tool in a forward and backward motion to avoid creating gouges in the work surface.

FIG. 12

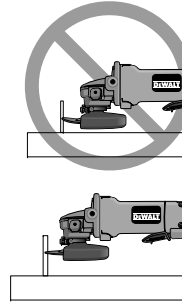
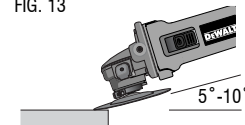

FIG. 13



5. Remove the tool from work surface before turning tool off. Allow the tool to stop rotating before laying it down.

MOUNTING SANDING BACKING PADS

⚠ CAUTION: Proper guard must be reinstalled for grinding wheel, sanding flap disc, wire brush or wire wheel applications after sanding applications are complete.

1. Place or appropriately thread the backing pad (N) on the spindle.
2. Place the sanding disc (O) on the backing pad.
3. While depressing the spindle lock button, thread the clamp nut (G) on the spindle, piloting the raised hub on the clamp nut into the center of sanding disc and backing pad. Release the spindle lock button.
4. Tighten the clamp nut by hand. Then depress the spindle lock button while turning the sanding disc until the sanding disc and clamp nut are snug.
5. To remove the wheel, grasp and turn the backing pad and sanding pad while depressing the spindle lock button.

FIG. 14

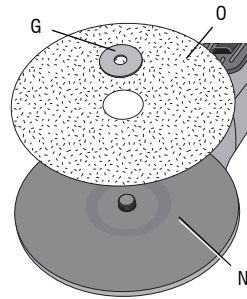

USING SANDING BACKING PADS

Choose the proper grit sandpaper for your application. Sandpaper is available in various grits. Coarse grits yield faster material removal rates and a rougher finish. Finer grits yield slower material removal and a smoother finish.

Begin with coarse grit discs for fast, rough material removal. Move to a medium grit paper and finish with a fine grit disc for optimal finish.

Coarse	16–30 grit
Medium	36–80 grit
Fine Finishing	100–120 grit
Very Fine Finishing	150–180 grit

1. Allow the tool to reach full speed before touching tool to the work surface.
2. Apply minimum pressure to work surface, allowing the tool to operate at high speed. Sanding rate is greatest when the tool operates at high speed.

3. Maintain a 5° to 15° angle between the tool and work surface. The sanding disc should contact approximately one inch of work surface.

FIG. 15

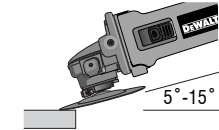

4. Move the tool constantly in a straight line to prevent burning and swirling of work surface. Allowing the tool to rest on the work surface without moving, or moving the tool in a circular motion causes burning and swirling marks on the work surface.
5. Remove the tool from work surface before turning tool off. Allow the tool to stop rotating before laying it down.

Mounting and Using Wire Brushes and Wire Wheels

⚠ WARNING: To reduce the risk of serious personal injury, turn off and unplug the tool before making any adjustments or removing or installing attachments or accessories. Before reconnecting the tool, depress and release the paddle switch to ensure that the tool is off.

Wire cup brushes or wire wheels screw directly on the grinder spindle without the use of flanges. Use only wire brushes or wheels provided with an M14 threaded hub. A Type 27 guard is required when using wire brushes and wheels.

⚠ CAUTION: Wear work gloves when handling wire brushes and wheels. They can become sharp.

⚠ CAUTION: Wheel or brush must not touch guard when mounted or while in use. Undetectable damage could occur to the accessory, causing wires to fragment from accessory wheel or cup.

MOUNTING WIRE BRUSHES AND WIRE WHEELS

1. Thread the wheel on the spindle by hand.
2. Depress spindle lock button and use a wrench on the hub of the wire wheel or brush to tighten the wheel.
3. To remove the wheel, reverse the above procedure.

⚠ CAUTION: Failure to properly seat the wheel hub before turning the tool on may result in damage to tool or wheel.

USING WIRE CUP BRUSHES AND WIRE WHEELS

Wire wheels and brushes can be used for removing rust, scale and paint, and for smoothing irregular surfaces.

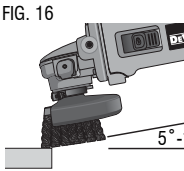
1. Allow the tool to reach full speed before touching the tool to the work surface.
2. Apply minimum pressure to work surface, allowing the tool to operate at high speed. Material removal rate is greatest when the tool operates at high speed.
3. Maintain a 5° to 10° angle between the tool and work surface for wire cup brushes.  FIG. 16
4. Maintain contact between the edge of the wheel and the work surface with wire wheels.
5. Continuously move the tool in a forward and backward motion to avoid creating gouges in the work surface. Allowing the tool to rest on the work surface without moving, or moving the tool in a circular motion causes burning and swirling marks on the work surface.
6. Remove the tool from the work surface before turning the tool off. Allow the tool to stop rotating before setting it down.

CAUTION: Use extra care when working over an edge, as a sudden sharp movement of grinder may be experienced.

Mounting and Using Cutting (Type 1) Wheels

WARNING: To reduce the risk of serious personal injury, turn off and unplug the tool before making any adjustments or removing or installing attachments or accessories. Before reconnecting the tool, depress and release the paddle switch to ensure that the tool is off. An accidental start-up can cause injury. Cutting wheels include diamond wheels and abrasive discs. Abrasive cutting wheels for metal and concrete use are available. Diamond blades for concrete cutting can also be used.

NOTE: All grinders that use Type 1 wheels use the quick-change backing flange (F).

WARNING: A closed, 2-sided cutting wheel guard is not included with this tool and is required when using cutting wheels. Failure to use proper flange and guard can result in injury resulting from wheel breakage and wheel contact. See pages 9–10 for more information.

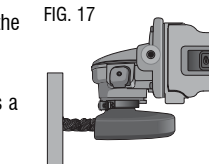

MOUNTING CLOSED (TYPE 1) GUARD

1. Open the guard latch (J). Align the lugs (K) on the guard with the slots (L) on the gear case.
2. Push the guard down until the guard lug engages and rotates freely in the groove on the gear case hub.
3. Rotate guard (H) into desired working position. The guard body should be positioned between the spindle and the operator to provide maximum operator protection.
4. Close the guard latch to secure the guard on the gear case cover. You should be unable to rotate the guard by hand when the latch is in closed position. If rotation is possible, tighten the adjusting screw (M) with clamp lever in the closed position. Do not operate grinder with a loose guard or clamp lever in open position.
5. To remove the guard, open the guard latch, rotate the guard so that the arrows are aligned and pull up on the guard.

NOTE: If, after a period of time, the guard becomes loose, tighten the adjusting screw (M) with the clamp lever in the closed position.

CAUTION: Do not tighten adjusting screw with clamp lever in open position. Undetectable damage to guard or mounting hub may result.

MOUNTING CUTTING WHEELS

CAUTION: Matching diameter backing flange and threaded clamp nut (included with tool) must be used for cutting wheels.

1. Place the quick-change backing flange on spindle with the raised section (pilot) facing up. The raised section (pilot) on the backing flange will be against the wheel when the wheel is installed.

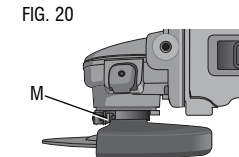
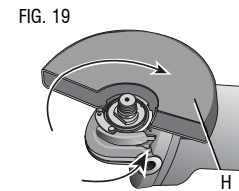
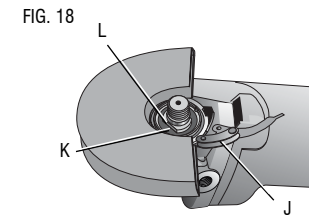

2. Place the wheel on the backing flange, centering the wheel on the raised section (pilot).
3. Install the threaded clamp nut with the raised section (pilot) facing away from the wheel.
4. Depress the spindle lock button and tighten clamp nut with a wrench.
5. To remove the wheel, grasp and turn while depressing the spindle lock button.

USING CUTTING WHEELS

⚠️ WARNING: Do not use edge grinding/ cutting wheels for surface grinding applications because these wheels are not designed for side pressures encountered with surface grinding. Wheel breakage and injury may result.

1. Allow tool to reach full speed before touching tool to work surface.
2. Apply minimum pressure to work surface, allowing tool to operate at high speed. Cutting rate is greatest when the tool operates at high speed.
3. Once a cut is begun and a notch is established in the workpiece, do not change the angle of the cut. Changing the angle will cause the wheel to bend and may cause wheel breakage.
4. Remove the tool from work surface before turning tool off. Allow the tool to stop rotating before setting it down.

MAINTENANCE

⚠️ WARNING: To reduce the risk of serious personal injury, turn off and unplug the tool before making any adjustments or removing or installing attachments or accessories. Before reconnecting the tool, depress and release the paddle switch to ensure that the tool is off. An accidental start-up can cause injury.

Lubrication

Your power tool requires no additional lubrication.

FIG. 21

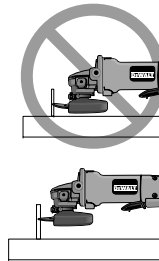

Cleaning

⚠️ WARNING: Blow dirt and dust out of all air vents with clean, dry air at least once a week. To minimize the risk of eye injury, always wear AS/NZS51337 approved eye protection when performing this.

⚠️ WARNING: Never use solvents or other harsh chemicals for cleaning the non-metallic parts of the tool. These chemicals may weaken the plastic materials used in these parts. Use a cloth dampened only with water and mild soap. Never let any liquid get inside the tool; never immerse any part of the tool into a liquid.

Repairs

To assure product SAFETY and RELIABILITY, repairs, maintenance and adjustment (including brush inspection and replacement) should be performed by certified service centers or other qualified service organizations, always using identical replacement parts.

ACCESSORIES

⚠️ WARNING: Since accessories, other than those offered by DEWALT, have not been tested with this product, use of such accessories with this tool could be hazardous. To reduce the risk of injury, only DEWALT recommended accessories should be used with this product. Recommended accessories for use with your tool are available at extra cost from your local service center. If you need any assistance in locating any accessory, please contact Stanley Black & Decker, 82 Taryn Drive, Epping, VIC 3076 Australia or call 1800 444 224 or (NZ) 0800 339 258.





Stanley Black & Decker
82 Taryn Drive, Epping, VIC 3076 Australia • 1800 444 224 (Aust) or 0800 339 258 (NZ)
www.dewalt.com.au • www.dewalt.co.nz

(JAN13) Part No. N254142 D28114N-XE Copyright © 2012, 2013 DeWALT

The following are trademarks for one or more DeWALT power tools: the yellow and black color scheme; the "D" shaped air intake grill; the array of pyramids on the handgrip; the kit box configuration; and the array of lozenge-shaped humps on the surface of the tool.